



Lithonia Residential Recessed

Lithonia Lighting offers a complete line of residential recessed products to meet the varying needs of our customers. The recessed line offers products with 3", 5" and 6" apertures in incandescent, low voltage and compact fluorescent sources.

Our housings are designed to provide the easiest installation in the industry while requiring the fewest SKUs for standard applications. All our recessed trims offer a full reflector design, which maximizes lamp position and provides an exceptional overall appearance.



CONTENTS



Incandescent Recessed

6" Aperture	298
5" Aperture	306
3" Aperture	308

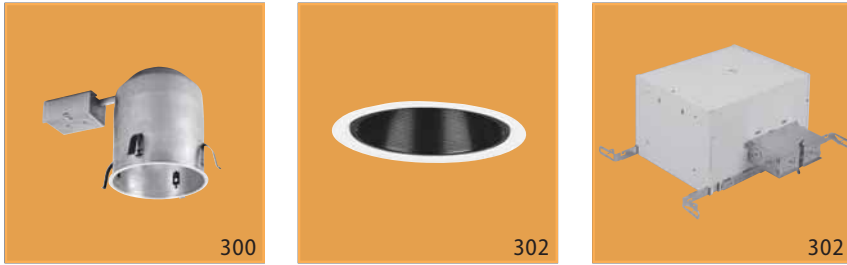

Low Voltage Recessed

3" Aperture	310
-------------	-----



Remodelers Recessed

313



Fluorescent Recessed

6" Aperture	314
-------------	-----



Specialty

Damp Location Steplights	319
Lensed Squares	320



Technical Information

Options & Accessories	321
Packaging	322
Lamp Performance	323

6" IC/Non-IC Housing

LC6 & L7X



Intended Use

Recessed housing rated IC or Non-IC for new construction applications. Approved for direct burial in insulation (IC) and through-branch circuit wiring. Approved for most wiring and ceiling types.

Features

Factory-installed captive bar hangers span 24" and feature built-in nailers and T-bar clips. Bar hanger locking screw holds fixture firmly in place.

Socket clips to trim to ensure proper and consistent lamp position. Product ships in retail pack of six (R6) only.

LC6 (Premium) – Injection-molded frame with aluminum can for superior thermal performance for a wider range of trims. Romex only (not for pulling wires). Featuring poke-home wire connectors, built-in Romex clamps and ground wire.

Suitable for ceilings up to 2-3/4" thick.

L7X (Standard) – Steel frame with aluminum can for superior thermal performance for a wider range of trims.

Air-tight standard. Meets current energy codes.

J-box has built in Romex clamps and ground wire.







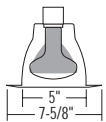
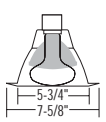
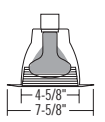
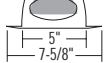

Suitable for ceiling up to 1" thick.

Listings

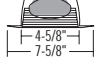
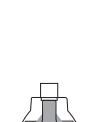
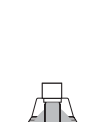
UL Listed to U.S. and Canadian safety standards.

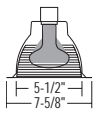
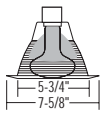
IC Rated Full Trims – All trims are damp location listed. Lensed trims are wet location listed. These IC trims also can be used in Non-IC applications using lamps and maximum wattages listed below. White flange standard.

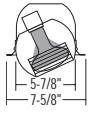
For additional IC rated trims, see page 304.

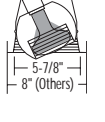
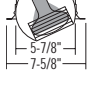
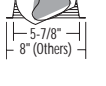
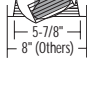
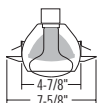
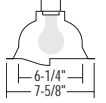
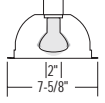
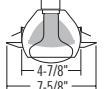
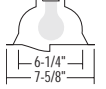
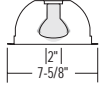
Premium open trim, wide flange	Standard open trim, narrow flange	Premium baffle, wide flange
601 White 	702 White ¹ 702A Clear diffuse 702AZ Clear specular 702G Gold diffuse 702GZ Gold specular 702BLZ Black specular 	6B1 Black 6B1W White 
65 BR30 75 PAR30 	65 BR30 75 PAR30 	40 A19 65 BR30 75 PAR30 
Premium deep baffle, narrow flange	Standard baffle, narrow flange	Premium open eyeball
6B2 Black 6B2W White 	7B2 Black 7B2W White ¹ 	6E1 White 
40 A19 65 BR30/BR40 75 PAR30/PAR38 	65 BR30 75 PAR30 	65 BR30 75 PAR30 
Premium baffle eyeball	Premium regressed open eyeball	Premium regressed baffle eyeball
6E2 White/black 6E2W White/white 	6RE1 Black/white 6RE1W White/white 	
65 BR30 75 PAR30 	65 BR30 75 PAR30 	65 BR30 75 PAR30 
Standard eyeball	Premium eyelid wallwash	Premium pinhole
7E1 White 	CW1 White 	CS1 White 
65 BR30 75 PAR30 	40 A19 	40 A19 50 R20 50 PAR20 

Ordering Information

Series	Options
LC6	AT Sealed airtight housing to minimize air flow through housing. Complies with WSEC and ASTM E283.
L7X	PHC Poke-home wire connectors.

Example: LC6

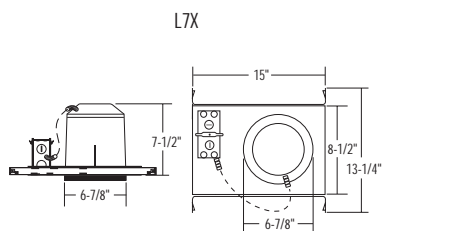
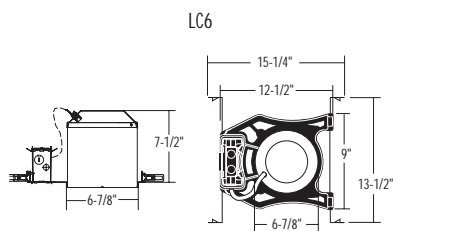

Premium polycarbonate lens

- CLF1** Flush opal¹
- CLF2** Flush prismatic¹
- CLD1** Drop opal¹
- CLD2** Drop prismatic¹

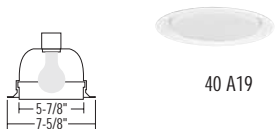

NOTES:

1 For plastic flange, add suffix PF to catalog number (Example: CLF1 PF).

IMPORTANT: For packaging information, see page 322. See specification sheets for complete trim selection.

Drawings are for dimensional detail only and may not represent actual mechanical configuration. Dimensions are shown in inches.

Non-IC Rated Full Trims – All trims are damp location listed. Lensed trims and WETlite™ are wet location listed. Lamp types and maximum wattages are listed for each trim. White flange standard.

Premium open trim, narrow flange

- 602 White
- 602SA Clear diffuse
- 602A Clear specular
- 602SG Gold diffuse
- 602G Gold specular

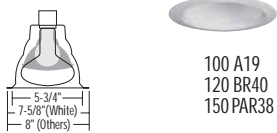

Premium baffle, narrow flange

- 6B4 Black
- 6B4W White

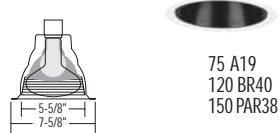

Standard baffle, narrow flange

- 7B5 Black
- 7B5W White¹

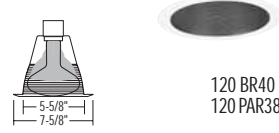

Premium open cone w/diffuse upper trim

- 6C3A Clear specular
- 6C3G Gold specular
- 6C3BL Black specular



Premium adjustable cone

- 6AC1A Clear specular
- 6AC1G Gold specular
- 6AC1BL Black specular



Premium adjustable baffle

- 6AB1 Black
- 6AB1W White

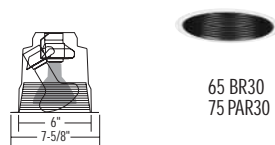

Premium eyelid wallwash

- 6W1 White

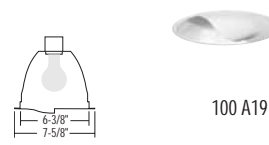

Premium eyelid wallwash w/baffle

- 6W2 Black
- 6W2W White

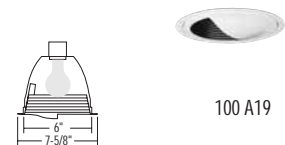

WETlite™

- 6H20 White
- (ships with outdoor-rated 75W PAR38 lamp)

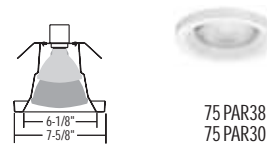

Glass lens

- 6LD3 Drop opal, white splay
- 6LDB3 Drop opal, black baffle
- 6LF3 Flush white, white splay
- 6LFB3 Flush white, black baffle
- 6L4 Fresnel, white splay
- 6LB4 Fresnel, black baffle

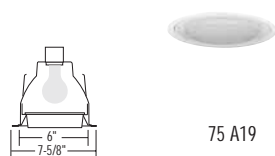

Premium polycarbonate lens

- 6LD1 Drop opal¹
- 6LD2 Drop prismatic¹
- 6LF1 Flush opal¹
- 6LF2 Flush prismatic¹

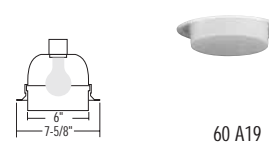

lightquick[®] XD
Express delivery products.

See page 11 for details about LightQuick XD.

Description

- LC6 R6
- L7X R6
- 6B1W M6

NOTES:

1 For plastic flange, add suffix PF to catalog number (Example: 6LD1PF).

IMPORTANT: For packaging information, see page 322. See specification sheets for complete trim selection.

Drawings are for dimensional detail only and may not represent actual mechanical configuration. Dimensions are shown in inches.

6" IC/Non-IC Remodel Housing

L7XR



Intended Use

Recessed housing rated IC or Non-IC for remodel applications. Approved for factory-assembled wiring only. Approved for direct burial in insulation (IC).

Features

One-piece aluminum self-flanged can provides maximum structural integrity.

J-box has built-in Romex clamps, ground wire, and snap on/off door for easy wiring. Approved for all ceiling types (including air-handling plenums). Not for pulling wires.

One-piece, heavy-gauge, galvanized steel raceway arm/J-box fits easily through ceiling opening.

Suitable for ceilings up to 1-1/2" thick. Four (4) factory-installed remodel clips lock housing in place and automatically adjust for ceiling thickness.











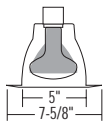

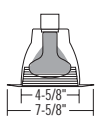
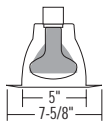

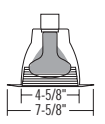

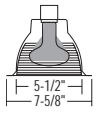
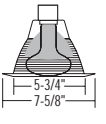

Socket clips to trim to ensure proper and consistent lamp position.

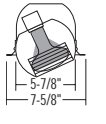
Listings

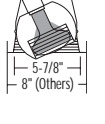
UL Listed to U.S. and Canadian safety standards.

IC Rated Full Trims – All trims are damp location listed. Lensed trims are wet location listed. These IC trims also can be used in Non-IC applications using lamps and maximum wattages listed below. White flange standard.

For additional IC rated trims, see page 304.

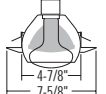
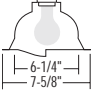
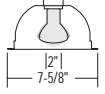
Premium open trim, wide flange	Standard open trim, narrow flange	Premium baffle, wide flange
601 White 	702 White ¹ 702A Clear diffuse 702AZ Clear specular 702G Gold diffuse 702GZ Gold specular 702BLZ Black specular 	6B1 Black 6B1W White 
		
65 BR30 75 PAR30	65 BR30 75 PAR30	40 A19 65 BR30 75 PAR30
Premium deep baffle, narrow flange	Standard baffle, narrow flange	Premium open eyeball
6B2 Black 6B2W White 	7B2 Black 7B2W White ¹ 	6E1 White 
		
40 A19 65 BR30/BR40 75 PAR30/PAR38	65 BR30 75 PAR30	65 BR30 75 PAR30
Premium baffle eyeball	Premium regressed open eyeball	Premium regressed baffle eyeball
6E2 White/black 6E2W White/white 	6RE1 Black/white 6RE1W White/white 	
		
65 BR30 75 PAR30	65 BR30 75 PAR30	65 BR30 75 PAR30
Standard eyeball	Premium eyelid wallwash	Premium pinhole
7E1 White 	CW1 White 	CS1 White 
		
65 BR30 75 PAR30	40 A19	40 A19 50 R20 50 PAR20

Ordering Information

Example: **L7XR**

Series	Options
L7XR	AT Sealed airtight housing to minimize air flow through housing. Complies with WSEC and ASTM E283. PHC Poke-home wire connectors.

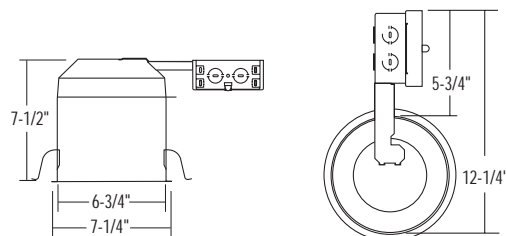

Premium polycarbonate lens

- CLF1** Flush opal¹
- CLF2** Flush prismatic¹
- CLD1** Drop opal¹
- CLD2** Drop prismatic¹

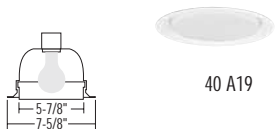









NOTES:

1 For plastic flange, add suffix PF to catalog number (Example: CLF1 PF).

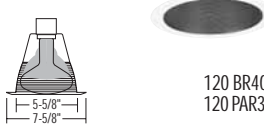
IMPORTANT: For packaging information, see page 322. See specification sheets for complete trim selection.

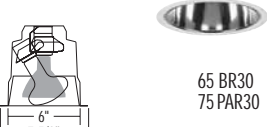
Drawings are for dimensional detail only and may not represent actual mechanical configuration. Dimensions are shown in inches.

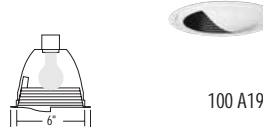
Non-IC Rated Full Trims – All trims are damp location listed. Lensed trims and WETlite™ are wet location listed. Lamp types and maximum wattages are listed for each trim. White flange standard.

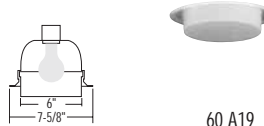
Premium open trim, narrow flange	Premium baffle, narrow flange	Standard baffle, narrow flange	Premium open cone w/diffuse upper trim
<p>602 White 602SA Clear diffuse 602A Clear specular 602SG Gold diffuse 602G Gold specular</p>  <p>100 A19 120 BR40 150 PAR38</p>	<p>6B4 Black 6B4W White</p>  <p>75 A19 120 BR40 150 PAR38</p>	<p>7B5 Black 7B5W White¹</p>  <p>120 BR40 150 PAR38</p>	<p>6C3A Clear specular 6C3G Gold specular 6C3BL Black specular</p>  <p>100 A19 120 BR40 150 PAR38</p>
Premium adjustable cone	Premium adjustable baffle	Premium eyelid wallwash	Premium eyelid wallwash w/baffle
<p>6AC1A Clear specular 6AC1G Gold specular 6AC1BL Black specular</p>  <p>65 BR30 75 PAR38</p>	<p>6AB1 Black 6AB1W White</p>  <p>65 BR30 75 PAR38</p>	<p>6W1 White</p>  <p>100 A19</p>	<p>6W2 Black 6W2W White</p>  <p>100 A19</p>
WETlite™	Glass lens	Premium polycarbonate lens	
<p>6H20 White (ships with outdoor-rated 75W PAR38 lamp)</p>  <p>75 PAR38 75 PAR30</p>	<p>6LD3 Drop opal, white splay 6LDB3 Drop opal, black baffle 6LF3 Flush white, white splay 6LFB3 Flush white, black baffle 6L4 Fresnel, white splay 6LB4 Fresnel, black baffle</p>  <p>75 A19</p>	<p>6LD1 Drop opal¹ 6LD2 Drop prismatic¹ 6LF1 Flush opal¹ 6LF2 Flush prismatic¹</p>  <p>60 A19</p>	

NOTES:

1 For plastic flange, add suffix PF to catalog number (Example: 6LD1PF).

IMPORTANT: For packaging information, see page 322. See specification sheets for complete trim selection.

Drawings are for dimensional detail only and may not represent actual mechanical configuration. Dimensions are shown in inches.

6" IC High Wattage/Sloped Ceiling Housing

LI6

IC Rated Full Trims – All trims are damp location listed. Lensed trims and WETlite™ are wet location listed. These IC trims also can be used in Non-IC applications using lamps and maximum wattages listed below. White flange standard.

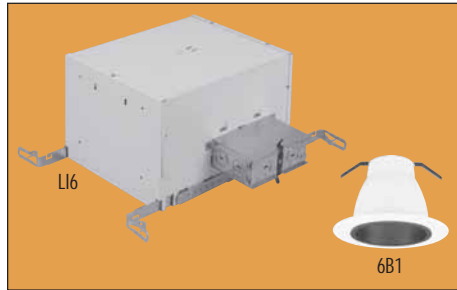

Intended Use

Recessed housing rated IC for new construction applications. Housing also can be used in Non-IC applications using lamps, wattages, and trims listed on page. Approved for direct burial in insulation and through-branch circuit wiring. Approved for most wiring and ceiling types.

Features

Pre-painted steel housing with galvanized steel J-box. Factory-installed, captive bar hangers span 24" and feature built-in nailers and T-bar clips. J-box has poke-home wire connectors and built-in Romex clamps. Socket clips to trim to ensure proper and consistent lamp position.

Listings

UL Listed to U.S. and Canadian safety standards.

Premium open trim, wide flange

601 White

60 A19
65 BR30
75 PAR30

Premium open trim, narrow flange

602 White
602SA Clear diffuse
602A Clear specular
602SG Gold diffuse
602G Gold specular

60 A19 (white)
75 A19 (others)
90 BR40
100 PAR38

Premium baffle, wide flange

6B1 Black
6B1W White

40 A19
65 BR30
75 PAR30

Deep baffle, narrow flange

6B2 Black
6B2W White

40 A19
65 BR30/BR40
75 PAR30
75 PAR38

Premium baffle, narrow flange

6B4 Black
6B4W White

75 A19
90 BR40
100 PAR38

Premium open cone w/diffuse upper trim

6C3A Clear specular
6C3G Gold specular
6C3BL Black specular

100 A19
90 BR40
100 PAR38

Premium adjustable cone

6AC1A Clear specular
6AC1G Gold specular
6AC1BL Black specular

65 BR30
75 PAR30

Premium adjustable baffle

6AB1 Black
6AB1W White

65 BR30
75 PAR30

Premium open eyeball

6E1 White

65 BR30
75 PAR30

Ordering Information

Example: **LI6**

Series	Options
LI6	AT Sealed airtight housing to minimize air flow through housing. Complies with WSEC and ASTM E283.

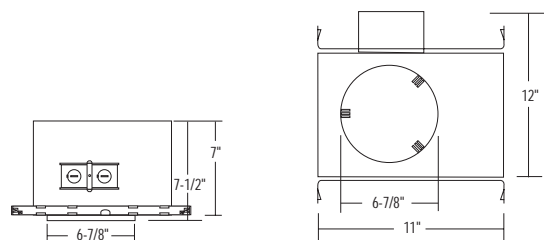

NOTES:
IMPORTANT: For packaging information, see page 322. See specification sheets for complete trim selection.

Drawings are for dimensional detail only and may not represent actual mechanical configuration. Dimensions are shown in inches.

6" IC High Wattage/Sloped Ceiling Housing

IC Rated Full Trims – All trims are damp location listed. Lensed trims and WETite™ are wet location listed. These IC trims also can be used in Non-IC applications using lamps and maximum wattages listed below. White flange standard.

Premium baffle eyeball

6E2 White/black
6E2W White/white



Premium regressed open eyeball

6RE1 Black/white
6RE1W White/white

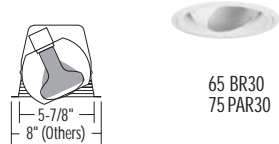

Premium regressed baffle eyeball

6RE2 Black/black
6RE2W White/white

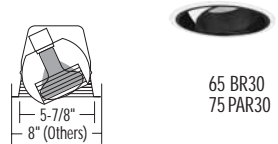

Premium eyelid wallwash

6W1 White

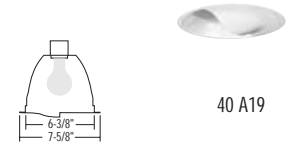

Premium eyelid wallwash w/baffle

6W2 Black
6W2W White

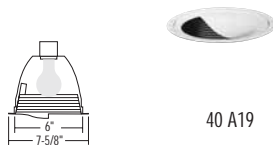

Premium pinhole

6S1 White

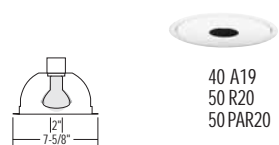

Glass lens

6LD3 Drop opal, white splay
6LDB3 Drop opal, black baffle
6LF3 Flush white, white splay
6LFB3 Flush white, black baffle
6L4 Fresnel, white splay
6LB4 Fresnel, black baffle

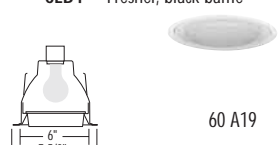

Premium polycarbonate lens

6LD1 Drop opal¹
6LD2 Drop prismatic¹
6LF1 Flush opal¹
6LF2 Flush prismatic¹

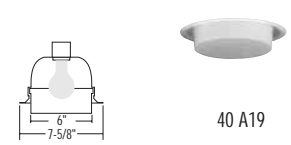

Sloped ceiling (Directs light straight down from 2/12 (9°) to 12/12 (45°) ceiling pitch.)

Premium open sloped ceiling

6S01 White

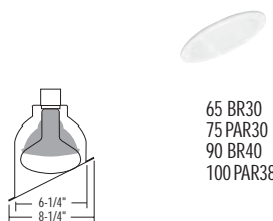

Premium baffled sloped ceiling

6SB1 Black
6SB1W White

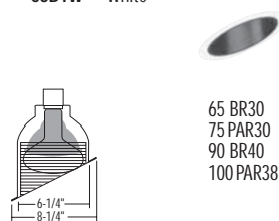

NOTES:

1 For plastic flange, add suffix PF to catalog number (Example: 6LD1PF).

IMPORTANT: For packaging information, see page 322. See specification sheets for complete trim selection.

Drawings are for dimensional detail only and may not represent actual mechanical configuration. Dimensions are shown in inches.

6" IC Shallow Housing

LCP & L7XP

IC Rated Full Trims – All trims are damp location listed. Lensed trims are wet location listed. These trims also can be used in Non-IC applications using lamps and maximum wattages listed below. White flange standard, except as noted.



Intended Use

Recessed housing rated IC for new construction applications. Housing also can be used in Non-IC applications using lamps, wattages, and trims listed on page. Approved for direct burial in insulation and through-branch circuit wiring. Approved for most wiring and ceiling types.

Features

Factory-installed captive bar hangers span 24" and feature built-in nailers and T-bar clips. Bar hanger locking screw holds fixture firmly in place. Socket clips to trim to ensure proper and consistent lamp position. Product ships in retail pack of six (R6) only.

LCP (Premium) – Injection-molded frame with aluminum can for superior thermal performance for a wider range of trims. Romex only. Not for pulling wires. J-box features poke-home wire connectors, built-in Romex clamps and ground wire. Suitable for ceilings up to 2-3/4" thick.

L7XP (Standard) – Steel frame with aluminum can for superior thermal performance for a wider range of trims. Air-tight standard. Meets current energy codes. J-box features poke-home wire connectors, built-in Romex clamps and ground wire. Suitable for ceiling up to 1" thick.

Listings

UL Listed to U.S. and Canadian safety standards.

Ordering Information

Series	Options
LCP	AT Sealed airtight housing to minimize air flow through housing. Complies with WSEC and ASTM E283.
L7XP	N/A

NOTES:

- 1 Flange matches trim finish.
- 2 For plastic flange, add suffix PF to catalog number (Example: CLF1 PF).

IMPORTANT: For packaging information, see page 322. See specification sheets for complete trim selection.

Drawings are for dimensional detail only and may not represent actual mechanical configuration. Dimensions are shown in inches.

Premium open trim, wide flange

C01 White

60 A19
65 BR30
75 PAR30

Premium open trim, narrow flange

C02 White
C02SA Clear diffuse¹
C02A Clear specular¹
C02GA Gold diffuse¹
C02G Gold specular¹

60 A19
65 BR30
75 PAR30

Standard open trim, wide flange

701 White

65 BR30
75 PAR30

Premium baffle, wide flange

CB1 Black
CB1W White

40 A19
65 BR30
75 PAR30

Standard baffle, wide flange

7B0 Black
7B0W White

65 BR30
75 PAR30

Premium open eyeball

CE1 White

75 PAR30

Standard eyeball

7E1 White

65 BR30
75 PAR30

Premium baffle eyeball

CE2 White/black
CE2W White/white

65 BR30
75 PAR30

Standard regressed eyeball

7RE1 White

65 BR30
50 PAR30

Premium eyelid wallwash

CW1 White

40 A19

Premium pinhole

CS1 White

40 A19
50 R20
50 PAR20

Premium polycarbonate lens

CLF1 Flush opal²
CLF2 Flush prismatic²
CLD1 Drop opal²
CLD2 Drop prismatic²

40 A19

Standard polycarbonate lens

7LD1 Drop opal
7LD1 PF Drop opal, plastic flange
7LD2 PF Drop prismatic, plastic flange

40 A19

Example: LCP

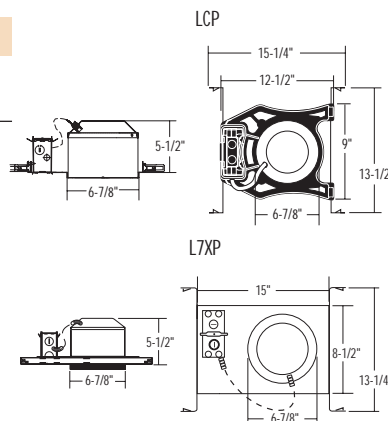

lightquick[®] XD
Express delivery products.
See page 11 for details about LightQuick XD.

Description
LCP R6
C01 M6

www.lithonia.com, keywords: LCP and L7XP

6" IC Shallow Remodel Housing

L7PR

IC Rated Full Trims – All trims are damp location listed. Lensed trims are wet location listed. These IC trims also can be used in Non-IC applications using lamps and maximum wattages listed below. White flange standard, except as noted.

Premium open trim, wide flange

C01 White



Premium open trim, narrow flange

C02 White
C02SA Clear diffuse¹
C02A Clear specular¹
C02GA Gold diffuse¹
C02G Gold specular¹



Standard open trim, wide flange

701 White



Premium baffle, wide flange

CB1 Black
CB1W White



Standard baffle, wide flange

7B0 Black
7B0W White

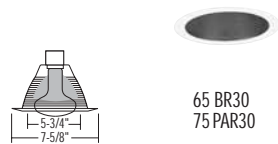

Premium open eyeball

CE1 White



Standard eyeball

7E1 White

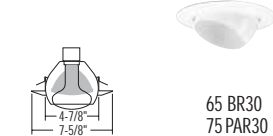

Premium baffle eyeball

CE2 White/black
CE2W White/white

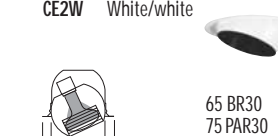

Standard regressed eyeball

7RE1 White

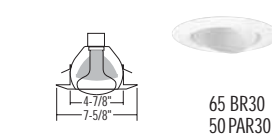

Premium eyelid wallwash

CW1 White

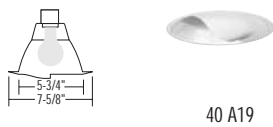

Premium pinhole

CS1 White

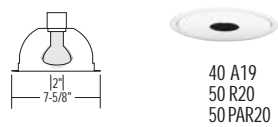

Premium polycarbonate lens

CLF1 Flush opal²
CLF2 Flush prismatic²
CLD1 Drop opal²
CLD2 Drop prismatic²

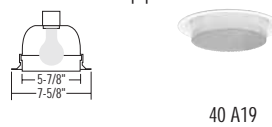

Standard polycarbonate lens

7LD1 Drop opal
7LD1 PF Drop opal, plastic flange
7LD2 PF Drop prismatic, plastic flange

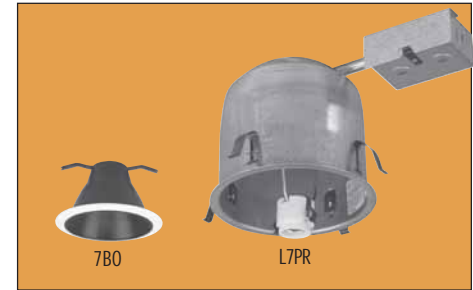

Intended Use

Recessed shallow housing rated IC for remodel applications. Housing also can be used in Non-IC applications using lamps, wattages, and trims listed on page. Approved for direct burial in insulation. Approved for most wiring and ceiling types.

Features

One-piece aluminum self-flanged can provides maximum structural integrity. J-box has built-in Romex clamps, ground wire, and snap on/off door for easy wiring. Not for pulling wires. One-piece, heavy-gauge, galvanized steel raceway arm/J-box fits easily through ceiling opening, existing ceiling. Suitable for ceilings up to 1/2" thick. Four (4) factory-installed remodel clips lock housing in place and automatically adjust for ceiling thickness. Socket clips to trim to ensure proper and consistent lamp position.

Listings

UL Listed U.S. and Canadian safety standards.

Ordering Information

Example: L7PR

Series	Options
L7PR	AT Sealed airtight housing to minimize air flow through housing. Complies with WSEC and ASTM E283. PHC Poke-home wire connectors.

NOTES:

- 1 Flange matches trim finish.
- 2 For plastic flange, add suffix PF to catalog number (Example: CLF1 PF).

IMPORTANT: For packaging information, see page 322. See specification sheets for complete trim selection.

Drawings are for dimensional detail only and may not represent actual mechanical configuration. Dimensions are shown in inches.

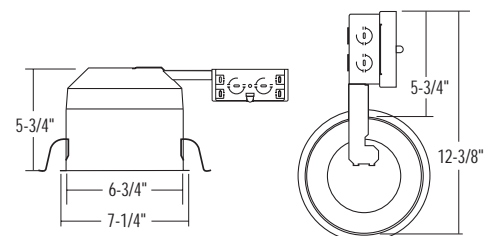

5" IC Housing

L5

IC Rated Full Trims – All trims are damp location. Lensed trims and WETlite™ are wet location listed. These IC trims also can be used in Non-IC applications using lamps and wattages listed below. White flange standard.



Intended Use

Recessed housing rated IC for new construction applications. Housing also can be used in Non-IC applications using lamps, wattages, and trims listed on page. Approved for direct burial in insulation and through-branch circuit wiring. Approved for most wiring and ceiling types.

Features

One-piece aluminum can. Galvanized steel rod frame and J-box. Factory-installed, captive bar hangers span 24" and feature built-in nailers and T-bar clips. Snap-lock rail clip locks fixture into place. J-box has built-in Romex clamps and a ground wire. Suitable for ceilings up to 2-3/4" thick. Socket clips to trim to ensure proper and consistent lamp position.

Listings

UL Listed to U.S. and Canadian safety standards.

Open trim, wide flange

501 White

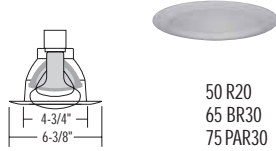

50 R20
65 BR30
75 PAR30

Deep baffle

5B2 Black
5B2W White

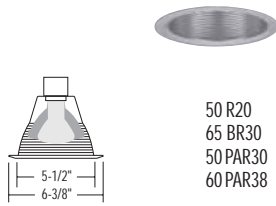

50 R20
65 BR30
50 PAR30
60 PAR38

WETlite™

5H20 White
(Ships with outdoor-rated 75W PAR38 lamp)

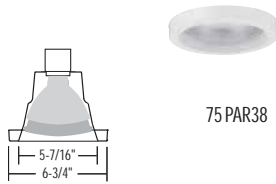

75 PAR38

Open trim, narrow flange

502 White
502A Clear diffuse
502AZ Clear specular
502G Gold diffuse
502GZ Gold specular
502BLZ Black specular

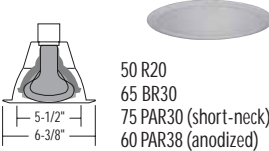

50 R20
65 BR30
75 PAR30 (short-neck)
60 PAR38 (anodized)

Eyeball

5E1 White

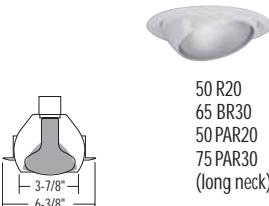

50 R20
65 BR30
50 PAR20
75 PAR30 (long neck)

Shallow baffle

5B1 Black
5B1W White

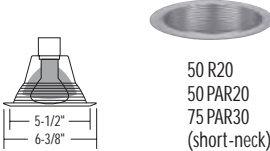

50 R20
50 PAR20
75 PAR30 (short-neck)

Polycarbonate lens

5LD1 Drop opal

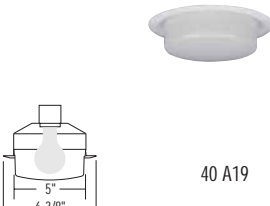

40 A19

Ordering Information

Example: L5

Series	Options
L5	AT Sealed airtight housing to minimize air flow through housing. Complies with WSEC and ASTM E283. PHC Poke-home wire connectors.

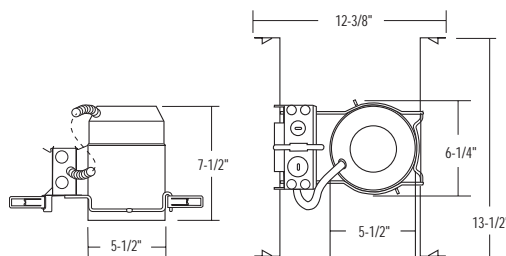

NOTES:
IMPORTANT: For packaging information, see page 322. See specification sheets for complete trim selection.

Drawings are for dimensional detail only and may not represent actual mechanical configuration. Dimensions are shown in inches.

L5R

IC Rated Full Trims – All trims are damp location listed. Lensed trims and WETlite™ are wet location listed. These IC trims also can be used in Non-IC applications using lamps and wattages listed below. White flange standard.

Open trim, wide flange

501 White

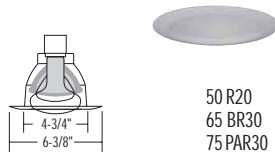

Open trim, narrow flange

502 White
502A Clear diffuse
502AZ Clear specular
502G Gold diffuse
502GZ Gold specular
502BLZ Black specular

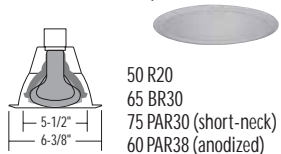

Shallow baffle

5B1 Black
5B1W White

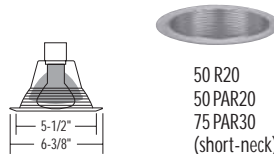

Deep baffle

5B2 Black
5B2W White

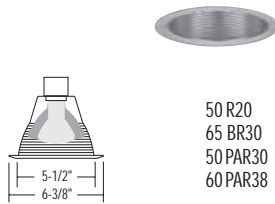

Eyeball

5E1 White

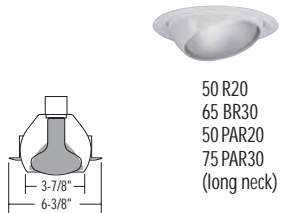

Polycarbonate lens

5LD1 Drop opal

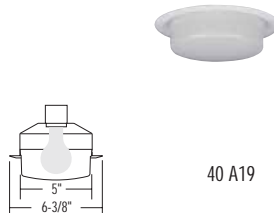

WETlite™

5H20 White
(Ships with outdoor-rated 75W PAR38 lamp)

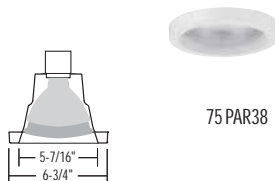

Intended Use

Recessed housing rated IC for remodel applications. Housing also can be used in Non-IC applications using lamps, wattages, and trims listed on page. Approved for direct burial in insulation. Approved for most wiring and ceiling types.

Features

One-piece aluminum self-flanged can provides maximum structural integrity. J-box has built-in Romex clamps, ground wire and snap on/off door for easy wiring. One-piece, heavy-gauge, galvanized steel raceway arm/J-box fit easily through ceiling opening. Not for pulling wires. Suitable for ceilings up to 1/2" thick. Four (4) factory installed remodel clips lock housing in place and automatically adjust for ceiling thickness. Socket clips to trim to ensure proper and consistent lamp position.

Listings

UL Listed to U.S. and Canadian safety standards.

Ordering Information

Example: **L5R**

Series	Options
L5R	AT Sealed airtight housing to minimize air flow through housing. Complies with WSEC and ASTM E283. PHC Poke-home wire connectors.

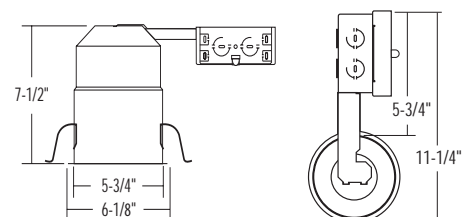

NOTES:
IMPORTANT: For packaging information, see page 322. See specification sheets for complete trim selection.

Drawings are for dimensional detail only and may not represent actual mechanical configuration. Dimensions are shown in inches.

3" IC/Non-IC Housing

LI3 & L3

IC/Non-IC Rated Full Trim – All trims are damp location listed. WETlite™ is listed for wet locations. Lamp types and maximum wattages are listed for each trim. White flange standard, except as noted.

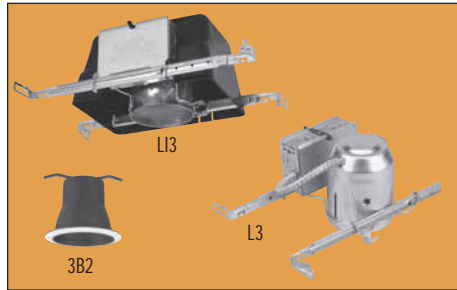

Intended Use

Recessed housing rated IC or Non-IC for new construction applications. Approved for direct burial in insulation (IC) and through-branch circuit wiring. Approved for most wiring and ceiling types.

Features

One-piece aluminum can. Compact thermal plastic shroud on LI3 for higher wattages in IC installations. Galvanized steel rod frame and J-box.

Factory-installed, captive bar hangers span 24" and feature built-in nailers and T-bar clips. Snap-lock rail clip locks fixture into place. J-box has built-in Romex clamps and a ground wire.

Suitable for ceilings up to 2" thick.

Socket clips to trim to ensure proper and consistent lamp position.

Listings

UL Listed to U.S. and Canadian safety standards.

Shallow open trim

- 301 White
- 301A Clear diffuse
- 301AZ Clear specular
- 301G Gold diffuse
- 301GZ Gold specular
- 301BLZ Black specular



IC (L3)	IC (LI3)	Non-IC (LI3)
30 R20	50 R20	50 PAR20
35 PAR20	50 PAR20	75 PAR16
	40 PAR16	

Deep, open trim

- 302 White
- 302A Clear diffuse
- 302AZ Clear specular
- 302G Gold diffuse
- 302GZ Gold specular
- 302BLZ Black specular



IC (LI3)	Non-IC (L3)
40 A19	50 PAR20
40 PAR16	60 PAR16
30 R20	
35 PAR20	

Shallow baffle

- 3B1 Black
- 3B1W White



IC (L3)	IC (LI3)	Non-IC (L3)
30 R20	50 R20	50 PAR20
35 PAR20	50 PAR20	75 PAR16
	40 PAR16	

Deep baffle

- 3B2 Black
- 3B2W White

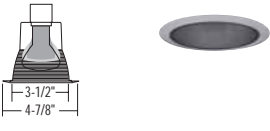

IC (LI3)	Non-IC (L3)
40 PAR16	50 PAR20
30 R20	45 PAR16
35 PAR20	

Wallwash

- 3W1 White

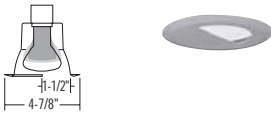

IC (LI3)	Non-IC (L3)
30 R20	50 R20
35 PAR20	50 PAR20
	40 PAR16

Eyeball

- 3E1 White



IC (L3)	IC (LI3)	Non-IC (L3)
35 PAR20	75 R20	50 R20
40 PAR16	50 PAR20	50 PAR20
75 PAR16		

Pinhole

- 3S1 White



IC (L3, LI3)	Non-IC (L3)
35 R20	50 R20
35 PAR20	35 PAR20
	45 PAR16

WETlite™

- 3H20 White
- 3H20PC Polished Chrome¹
- 3H20CP Polished Copper¹

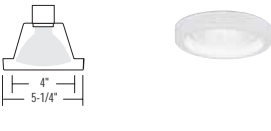

IC (LI3)	IC (L3)
75 PAR30	75 PAR30

(Ships with outdoor-rated 75W PAR30 lamp)

Ordering Information

Example: **L3**

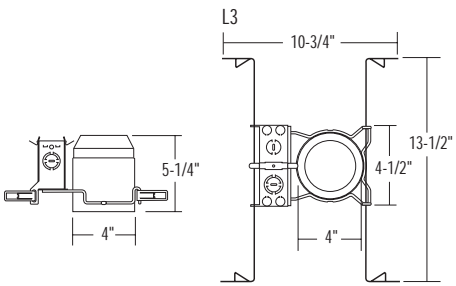
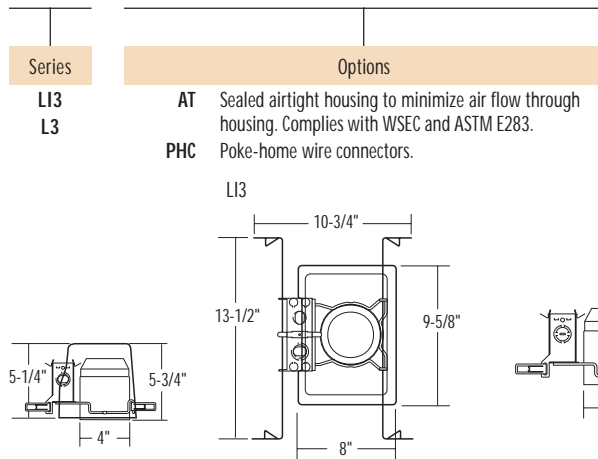

lightquick[®] XD
Express delivery products.
See page 11 for details about LightQuick XD.

Description
L3 M6
3B1W M12
3E1 M6
3H20

NOTES:
1 Flange matches trim finish.















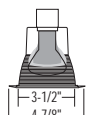

IMPORTANT: For packaging information, see page 322. See specification sheets for complete trim selection.

Drawings are for dimensional detail only and may not represent actual mechanical configuration. Dimensions are shown in inches.

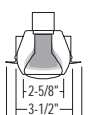
www.lithonia.com, keywords: LI3 and L3

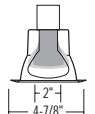
L3R

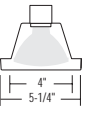
IC/Non-IC Rated Full Trims – All trims are damp location listed. WETlite™ is listed for wet locations. Lamp types and maximum wattages are listed for each trim. White flange standard.

Shallow open trim		Deep, open trim		Shallow baffle	
301 White		302 White		3B1 Black	
301A Clear diffuse		302A Clear diffuse		3B1W White	
301AZ Clear specular		302AZ Clear specular			
301G Gold diffuse		302G Gold diffuse			
301GZ Gold specular		302GZ Gold specular			
301BLZ Black specular		302BLZ Black specular			
					
IC 30 R20 35 PAR20	Non-IC 50 PAR20 75 PAR16	IC 30 R20 35 PAR20	Non-IC 40 A19 50 PAR20 60 PAR16	IC 30 R20 35 PAR20	Non-IC 50 PAR20 75 PAR16
Deep baffle		Wallwash		Eyeball	
3B2 Black		3W1 White		3E1 White	
3B2W White					
					
	Non-IC 75 R20 50 PAR20 45 PAR16		Non-IC 50 R20 35 PAR20 40 PAR16	IC 50 R29 35 PAR20 40 PAR16	Non-IC 50 R20 35 PAR20 45 PAR16
Pinhole		WETlite™			
3S1 White		3H20 White			
		3H20PC Polished Chrome ¹			
		3H20CP Polished Copper ¹			
					
	Non-IC 50 R20 35 PAR20 45 PAR16		IC 75 PAR30 (Ships with outdoor-rated 75W PAR30 lamp)		



Intended Use

Recessed housing rated IC or Non-IC for remodel applications. Approved for direct burial in insulation (IC). Approved for most wiring and ceiling types

Features

One-piece aluminum self-flanged can provides maximum structural integrity.
 J-box has built-in Romex clamps, ground wire and snap on/off door for easy wiring. Not for pulling wires.
 One-piece, heavy-gauge, galvanized steel raceway arm/J-box fit easily through ceiling opening.
 Suitable for ceilings up to 1/2" thick. Four (4) factory-installed remodel clips lock housing in place and automatically adjust for ceiling thickness.
 Socket clips to trim to ensure proper and consistent lamp position.

Listings

UL Listed to U.S. and Canadian safety standards.

lightquick[®] XD
Express delivery products.
 See page 11 for details about LightQuick XD.

Description

L3R M6
 3B1W M12
 3E1 M6
 3H20

NOTES:
 1 Flange matches trim finish.

IMPORTANT: For packaging information, see page 322. See specification sheets for complete trim selection.

Drawings are for dimensional detail only and may not represent actual mechanical configuration. Dimensions are shown in inches.

Ordering Information

Example: **L3R**

Series	Options
L3R	<p>AT Sealed airtight housing to minimize air flow through housing. Complies with WSEC and ASTM E283.</p> <p>PHC Poke-home wire connectors.</p>

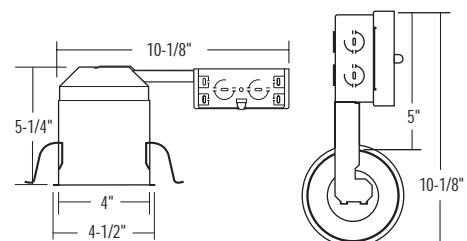

3" Non-IC Housing

LV3

Non-IC Rated Trims – These trims are for Non-IC applications when used with the LV3 housing. Lamp types and maximum wattages are listed for each trim. White flange standard, except as noted.

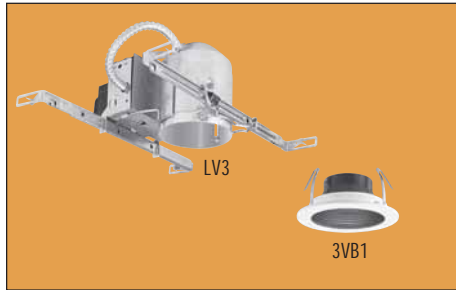

Intended Use

Recessed housing rated Non-IC for new construction applications. Thermally protected against improper contact with insulation and approved for through-branch circuit wiring. Approved for most wiring and ceiling types.

Features

One-piece aluminum can for superior thermal performance for a wider range of trims. Galvanized steel rod frame and J-box. Factory-installed captive bar hangers span 24" and feature built-in nailers and T-bar clips. Suitable for ceilings up to 2" thick in new construction only. Precision-wound stepdown transformer with class H insulation. For dimming control, use only dimmers specifically designed for use with magnetic (core and coil) transformers. Consult factory when using fixtures on dimming systems. Two-pin porcelain socket attaches to lamp. Lamp clips to trim to ensure proper and consistent position.

Listings

UL Listed to U.S. and Canadian safety standards.

Adjustable open cone

- 3V01AZ Clear specular
- 3V01GZ Gold specular
- 3V01BLZ Black specular

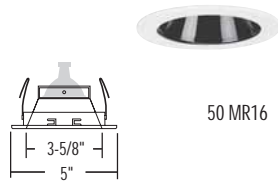

Adjustable baffle

- 3VB1 Black
- 3VB1W White

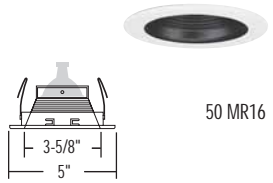

Open eyeball

- 3VE1 White

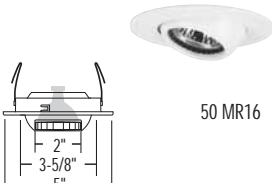

Baffle eyeball

- 3VE2 Black
- 3VE2W White

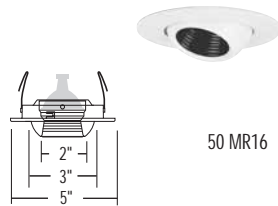

Eyelid wallwash

- 3VW1 White

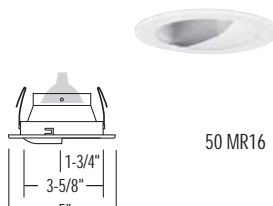

Adjustable wallwash

- 3VDW1W White

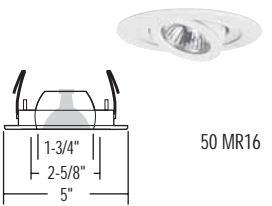

Adjustable slotted

- 3VA5 White baffle

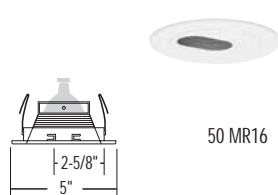

Pinhole

- 3VS1 Black baffle

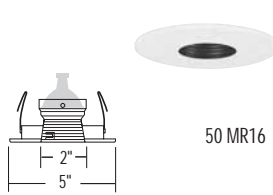

Ordering Information

Example: **LV3 120**

Series	Voltage	Options
LV3	120 277 347	PHC Poke-home wire connectors.

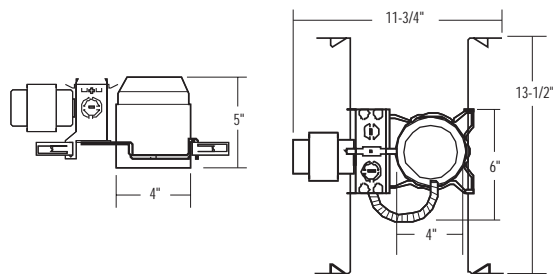

NOTES:
IMPORTANT: For packaging information, see page 322. See specification sheets for complete trim selection.

Drawings are for dimensional detail only and may not represent actual mechanical configuration. Dimensions are shown in inches.

LIV3

IC Rated Trims – All trims are damp location listed. Lamp types and maximum wattages listed for each trim. These IC trims also can be used in Non-IC applications using lamps and wattages listed below. White flange standard.

Adjustable open cone

- 3V01AZ Clear specular
- 3V01GZ Gold specular
- 3V01BLZ Black specular

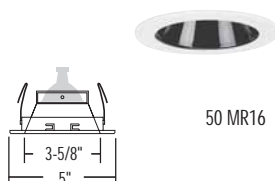

Adjustable baffle

- 3VB1 Black
- 3VB1W White

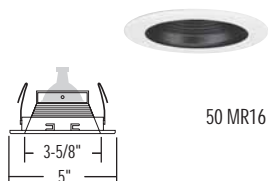

Open eyeball

- 3VE1 White

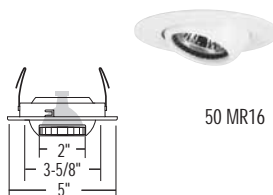

Baffle eyeball

- 3VE2 Black
- 3VE2W White

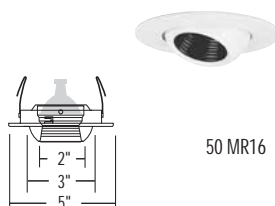

Eyelid wallwash

- 3VW1 White

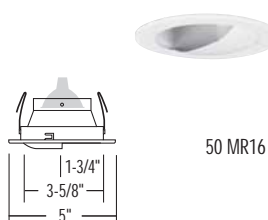

Adjustable wallwash

- 3VDW1W White

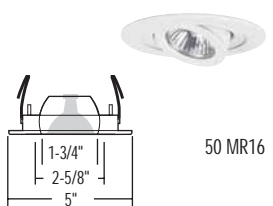

Adjustable slotted

- 3VA5 White baffle

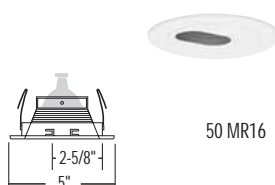

Pinhole

- 3VS1 Black baffle

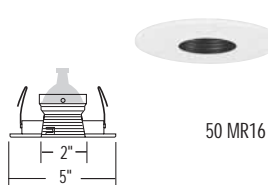

Intended Use

Recessed housing rated IC for new construction applications. Approved for direct burial in insulation and through-branch circuit wiring. Approved for most wiring and ceiling types.

Features

Air-tight standard. Meets current energy codes. Pre-painted steel inner housing and aluminum outer housing mounted to a rugged galvanized steel pan. Captive bar hangers span 24" and feature built-in nailers and T-bar clips. Suitable for ceilings up to 1-1/2" thick in new construction only. Precision-wound stepdown transformer with class H insulation. For dimming control, use only dimmers specifically designed for use with magnetic (core and coil) transformers. Consult factory when using fixtures on dimming systems. Two-pin porcelain socket attaches to lamp. Lamp clips to trim to ensure proper and consistent position.

Listings

CSA Certified to U.S. and Canadian safety standards.

Ordering Information

Example: **LIV3 120**

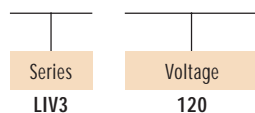

NOTES:

IMPORTANT: For packaging information, see page 322. See specification sheets for complete trim selection.

Drawings are for dimensional detail only and may not represent actual mechanical configuration. Dimensions are shown in inches.

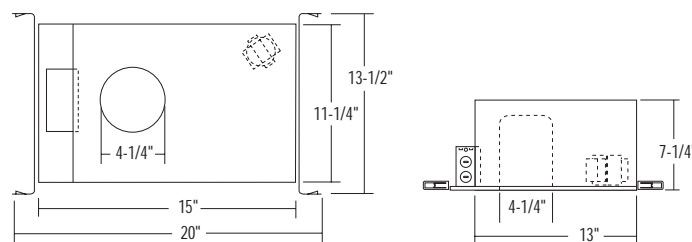

3" Non-IC Remodel Housing

LV3R

Non-IC Rated Trims – All trims are damp location listed. Lamp types and maximum wattages are listed for each trim. White flange standard.



Intended Use

Recessed housing rated Non-IC for remodel applications. Thermally protected against improper contact with insulation. Approved for most wiring and ceiling types.

Features

One-piece aluminum can for maximum integrity and superior thermal performance.
 Four (4) factory-installed clips automatically adjust for ceiling thickness up to 1/2" thick and lock housing in place with self-flange can.
 Galvanized steel J-box has built-in Romex clamps and ground wire. Not suitable for pulling wires, Romex only.
 Precision-wound stepdown transformer with class H insulation. For dimming control, use only dimmers specifically designed for use with magnetic (core and coil) transformers.
 Consult factory when using fixtures on dimming systems.
 Two-pin porcelain socket attaches to lamp. Lamp clips to trim to ensure proper and consistent position.

Listings

UL Listed to U.S. and Canadian safety standards.

Adjustable open cone

- 3V01AZ Clear specular
- 3V01GZ Gold specular
- 3V01BLZ Black specular

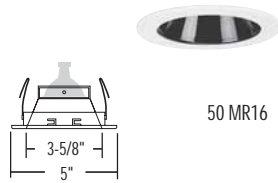

Adjustable baffle

- 3VB1 Black
- 3VB1W White

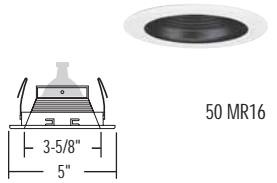

Open eyeball

- 3VE1 White

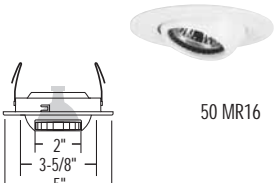

Baffle eyeball

- 3VE2 Black
- 3VE2W White

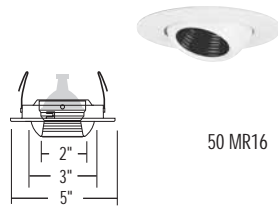

Eyelid wallwash

- 3VW1 White

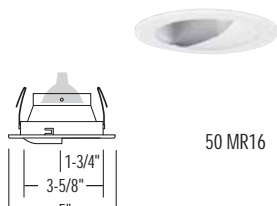

Adjustable wallwash

- 3VDW1W White

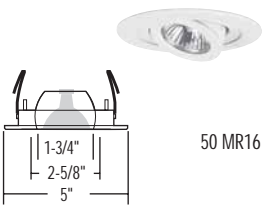

Adjustable slotted

- 3VA5 White baffle

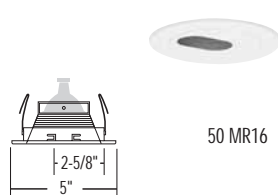

Pinhole

- 3VS1 Black baffle

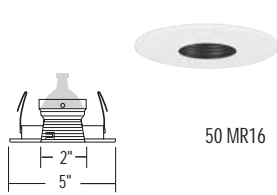

Ordering Information

Example: **LV3R 120**

Series	Voltage	Options
LV3R	120 277 347	PHC Poke-home wire connectors.

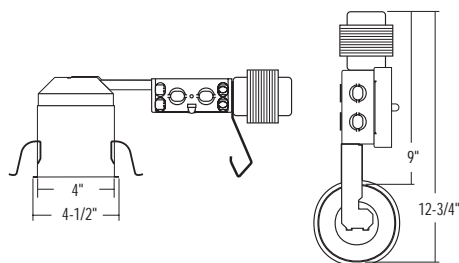

NOTES:
IMPORTANT: For packaging information, see page 322. See specification sheets for complete trim selection.

Drawings are for dimensional detail only and may not represent actual mechanical configuration. Dimensions are shown in inches.

5" & 3" Economy Remodeler

5" Incandescent
3" Incandescent

5" Incandescent - EE1 is rated IC. All others are for Non-IC applications only. EL1 is wet location listed. All others are damp location only. White flange standard.

<p>Open trim</p> <p>E01 White</p> <p>60 A19 65 BR30 75 PAR30</p>	<p>Baffle</p> <p>EB1 Black EB1W White</p> <p>40 A19 65 BR30 75 PAR30</p>	<p>Polycarbonate lens</p> <p>EL1 Drop opal</p> <p>40 A19</p>
<p>Eyeball</p> <p>EE1 White</p> <p>65 BR30 75 PAR30</p>		

3" Incandescent - All models are for Non-IC applications and rated for damp locations only. White flange standard.

<p>Open trim</p> <p>E301 White</p> <p>50 R20 50 PAR20</p>	<p>Shallow baffle</p> <p>E3B1 Black E3B1W White</p> <p>50 R20 50 PAR20</p>	<p>Eyeball</p> <p>E3E1 White</p> <p>50 R20 50 PAR20</p>
---	--	---



Intended Use

Economy remodelers rated Non-IC for remodel applications.

Features

Deep-drawn aluminum trim/housing eliminates need for separate can and trim.

Galvanized steel mounting ring holds trim/housing securely in ceilings from 1/8" to 1" thick.

Thermally protected against improper contact with insulation or overlampping. EE1 is IC rated; all other units are Non-IC. EL1 is wet location listed; all other units are damp location only.

Snap-on splice box provided with ground wire and pry-outs for Romex clamp (by others). Approved for end-of-run only.

Listings

UL Listed to U.S. and Canadian safety standards.

Ordering Information

Example: E01



5" Incandescent E Series

- E01 White open trim
- EB1 Black baffle
- EB1W White baffle
- EL1 Drop opal lens
- EE1 White eyeball

3" Incandescent E Series

- E301 White open trim
- E3B1 Black baffle
- E3B1W White baffle
- E3E1 White eyeball

NOTES:

IMPORTANT: For packaging information, see page 322. See specification sheets for complete trim selection.

Drawings are for dimensional detail only and may not represent actual mechanical configuration. Dimensions are shown in inches.

6" IC/Non-IC Housing

L7XF

IC/Non-IC Rated Full Trims – All trims are damp location listed. Lensed trims are listed for wet locations. Lamp types and maximum wattages are listed for each trim. White flange standard.

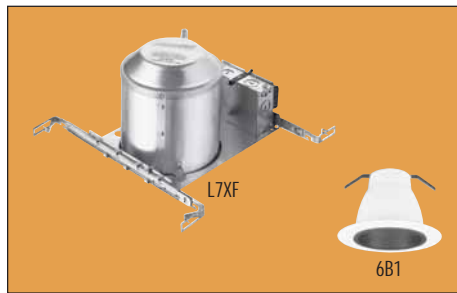

Intended Use

Recessed housing rated IC or Non-IC for new construction applications. Approved for direct burial in insulation (IC) and through-branch circuit wiring. Approved for most wiring and ceiling types.

Features

Air-tight standard. Meets current energy codes. All electromagnetic ballasts are high-power factor (HPF) except 13W DTT, 120V. Available with multi-volt (MVOLT) electronic ballast, 120 through 277, with end of life protection. Steel frame with aluminum can for superior thermal performance for a wider range of trims. Factory-installed captive bar hangers span 24" and feature built-in nailers and T-bar clips. Two bar hanger locking screws holds fixture in position. J-box features poke-home wire connectors, built-in Romex clamps and ground wire. Socket bracket clips to trim to ensure proper and consistent lamp position. Suitable for ceilings up to 1" thick.

Listings

UL Listed to U.S. and Canadian safety standards.

Premium open trim, wide flange

601 White

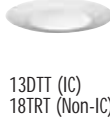
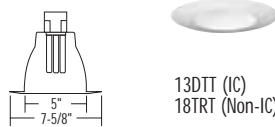

13DTT (IC)
18TRT (Non-IC)

Standard open trim, narrow flange

702 White¹
702A Clear diffuse
702AZ Clear specular
702G Gold diffuse
702GZ Gold specular
702BLZ Black specular



13DTT (IC)

Premium baffle, wide flange

6B1 Black
6B1W White

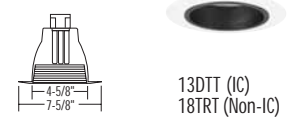

13DTT (IC)
18TRT (Non-IC)

Premium deep baffle, narrow flange

6B2 Black
6B2W White

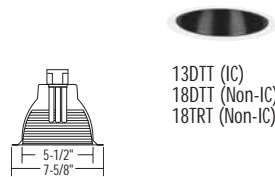

13DTT (IC)
18DTT (Non-IC)
18TRT (Non-IC)

Premium baffle, narrow flange

6B4 Black
6B4W White

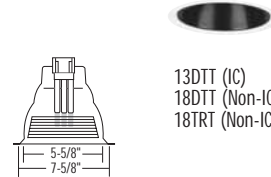

13DTT (IC)
18DTT (Non-IC)
18TRT (Non-IC)

Standard baffle, narrow flange

7B2 Black
7B2W White¹

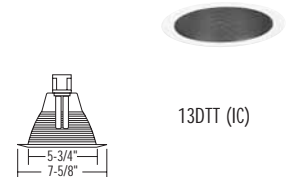

13DTT (IC)

Standard deep baffle, narrow flange

7B5 Black
7B5W White¹

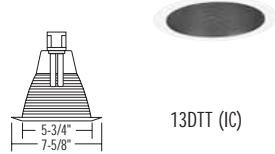

13DTT (IC)

Premium eyelid wallwash

6W1 White

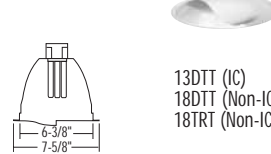

13DTT (IC)
18DTT (Non-IC)
18TRT (Non-IC)

Premium eyelid wallwash w/baffle

6W2 Black
6W2W White

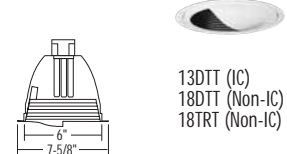

13DTT (IC)
18DTT (Non-IC)
18TRT (Non-IC)

Ordering Information

Series	Wattage/lamps	Voltage	Options
L7XF	13DTT 18DTT 18DTT/TRT 26TRT	MVOLT 120 277 347	GEB10 Generic electronic ballast. HPF High power electromagnetic factor ballast (90% power factor).

Example: L7XF 18DTT/TRT MVOLT

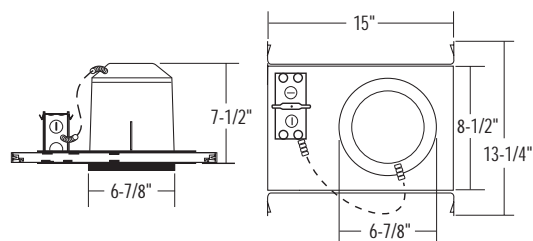

NOTES:

1 For plastic flange, add suffix PF to catalog number (Example: 7B2WPF).

IMPORTANT: For packaging information, see page 322. See specification sheets for complete trim selection.

Drawings are for dimensional detail only and may not represent actual mechanical configuration. Dimensions are shown in inches.

IC/Non-IC Rated Full Trims – All trims are damp location listed. Lensed trims are listed for wet locations. Lamp types and maximum wattages are listed for each trim. White flange standard.

Premium glass lens

- 6LD3 Drop opal, white splay
- 6LDB3 Drop opal, black baffle
- 6LF3 Flush white, white splay
- 6LFB3 Flush white, black baffle
- 6L4 Fresnel, white splay
- 6LB4 Fresnel, black baffle

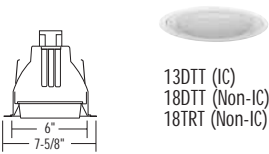

Premium polycarbonate lens

- 6LD1 Drop opal¹
- 6LD2 Drop prismatic¹
- 6LF1 Flush opal¹
- 6LF2 Flush prismatic¹

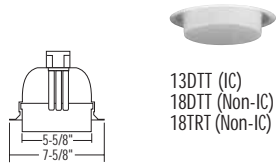

Standard polycarbonate lens

- 7LD1 Drop opal
- 7LD1 PF Drop opal, plastic flange
- 7LD2 PF Drop prismatic, plastic flange

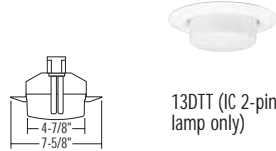

NOTES:

1 For plastic flange, add suffix PF to catalog number (Example: 6LD1PF).

IMPORTANT: For packaging information, see page 322. See specification sheets for complete trim selection.

Drawings are for dimensional detail only and may not represent actual mechanical configuration. Dimensions are shown in inches.

6" IC/Non-IC Housing

L7XF RECF

IC/Non-IC Rated Full Trims – All trims are damp location listed. Lensed trims are listed for wet locations. Lamp types and maximum wattages are listed for each trim. White flange standard.

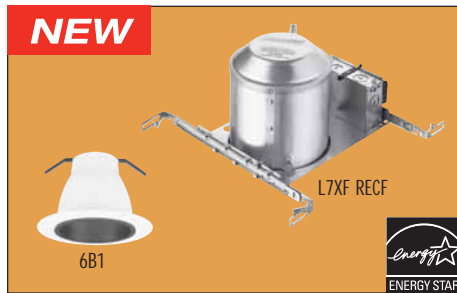

Intended Use

Recessed housing rated IC or Non-IC for new construction applications. Approved for direct burial in insulation (IC) and through-branch wiring. Approved for most wiring and ceiling types.

Features

Steel frame with aluminum can for superior thermal performance for a wider range of trims.

Factory-installed, captive bar hangers span 24" and features built-in nailers and T-bar clips.

J-box has poke-home connectors and built-in Romex clamps. Socket clips to trim to ensure proper and consistent lamp position.

120V only electronic ballast standard (4-pin lamp) with end of life protection.

Class P thermally protected against improper contact with insulation.

Listings

UL Listed to U.S. and Canadian safety standards. Approved for FCC grade B residential use.

Premium open trim, wide flange

601 White

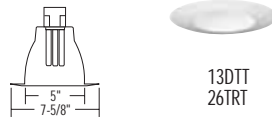

13DTT
26TRT

Premium deep baffle, narrow flange

6B2 Black
6B2W White

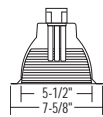

18DTT
26TRT

Premium eyelid wallwash w/baffle

6W2 Black
6W2W White

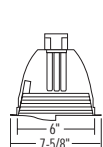

18DTT
26TRT

Premium open trim, narrow flange

602 White
602SA Clear diffuse
602A Clear specular
602SG Gold diffuse
602G Gold specular

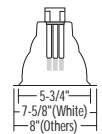

13DTT
26TRT

Premium baffle, narrow flange

6B4 Black
6B4W White

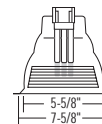

18DTT
26TRT

Premium glass lens

6LD3 Drop opal, white splay
6LDB3 Drop opal, black baffle
6LF3 Flush white, white splay
6LFB3 Flush white, black baffle
6L4 Fresnel, white splay
6LB4 Fresnel, black baffle

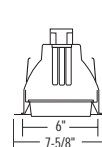

18DTT
26TRT

Premium baffle, wide flange

6B1 Black
6B1W White

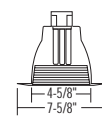

18DTT
26TRT

Premium eyelid wallwash

6W1 White

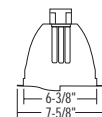

18DTT
26TRT

Premium polycarbonate lens

6LD1 Drop opal¹
6LD2 Drop prismatic¹
6LF1 Flush opal¹
6LF2 Flush prismatic¹

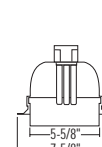

18DTT
26TRT

Ordering Information

Example: **L7XF 26TRT 120 RECF**

Series	Wattage/lamps	Voltage
L7XF	13DTT/TRT 18DTT/TRT 26TRT	120 RECF Residential-grade electronic ballast

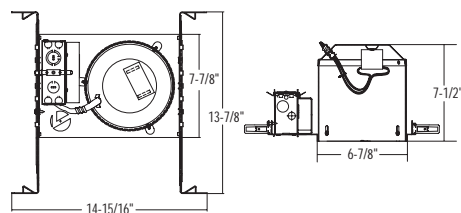

NOTES:

1 For plastic flange, add suffix PF to catalog number (Example: 6LD3 PF).

IMPORTANT: For packaging information, see page 322. See specification sheets for complete trim selection.

Drawings are for dimensional detail only and may not represent actual mechanical configuration. Dimensions are shown in inches.

LI6F RECF

IC Rated Full Trims – All trims are damp location listed. Lensed trims are wet location listed. These IC trims also can be used in Non-IC applications using lamps and maximum wattages listed below. White flange standard.

Premium open trim, wide flange

601 White

13DTT
26TRT

Premium open trim, narrow flange

602 White
602SA Clear diffuse
602A Clear specular
602SG Gold diffuse
602G Gold specular

13DTT
26TRT

Premium baffle, wide flange

6B1 Black
6B1W White

18DTT
26TRT

Premium deep baffle, narrow flange

6B2 Black
6B2W White

18DTT
26TRT

Premium baffle, narrow flange

6B4 Black
6B4W White

18DTT
26TRT

Premium eyelid wallwash

6W1 White

18DTT
26TRT

Premium eyelid wallwash w/baffle

6W2 Black
6W2W White

18DTT
26TRT

Premium glass lens

6LD3 Drop opal, white splay
6LDB3 Drop opal, black baffle
6LF3 Flush white, white splay
6LFB3 Flush white, black baffle
6L4 Fresnel, white splay
6LB4 Fresnel, black baffle

18DTT
26TRT

Premium polycarbonate lens

6LD1 Drop opal¹
6LD2 Drop prismatic¹
6LF1 Flush opal¹
6LF2 Flush prismatic¹

18DTT
26TRT

Sloped ceiling (Directs light straight down from 2/12 (9°) to 12/12 (45°) ceiling pitch.)

Open sloped ceiling

6S01 White

18DTT
26TRT

Baffled sloped ceiling

6SB1 Black
6SB1W White

18DTT
26TRT

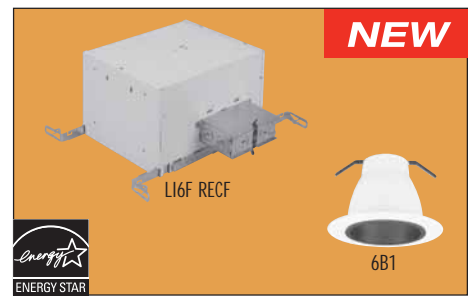

Intended Use

Recessed housing rated IC for new construction applications. Housing also can be used in Non-IC applications using lamps, wattages, and trims listed on page. Approved for direct burial in insulation (IC) and through-branch wiring. Approved for most wiring and ceiling types.

Features

Pre-painted steel housing with galvanized steel J-box. Factory-installed, captive bar hangers span 24" and features built-in nailers and T-bar clips. J-box has poke-home connectors and built-in Romex clamps. Socket clips to trim to ensure proper and consistent lamp position. 120V only electronic ballast standard (4-pin lamp) with end of life protection. Class P thermally protected against improper contact with insulation.

Listings

UL Listed to U.S. and Canadian safety standards. Approved for FCC grade B residential use.

Ordering Information

Example: **LI6F 26TRT 120 RECF ADEZ**

Series	Wattage/lamps	Voltage	Options
LI6F	13DTT/TRT 18DTT/TRT 26TRT	120 RECF 120 RECF ADEZ	AT Sealed airtight housing to minimize air flow through housing. Complies with WSEC and ASTM E283.

NOTES:
1 For plastic flange, add suffix PF to catalog number (Example: 6LD1 PF).
IMPORTANT: For packaging information, see page 322. See specification sheets for complete trim selection.
Drawings are for dimensional detail only and may not represent actual mechanical configuration. Dimensions are shown in inches.

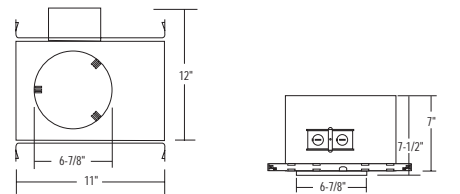

6" IC Master/Remote Housing

CKP62

IC Rated Full Trims – All trims are damp location listed. Lensed trims are wet location listed. These IC trims also can be used in Non-IC applications using lamps and maximum wattages listed below. White flange standard.



Intended Use

Recessed housing rated IC for new construction applications. Housing also can be used in Non-IC applications using lamps, wattages and trims listed on page. Approved for direct burial in insulation and through-branch wiring. Approved for most wiring and ceiling types.

Features

Steel frame with aluminum can for superior thermal performance for a wider range of trims. 11' inter-connection cable provided with remote unit. Master connector provided with remote unit. Factory-installed, captive bar hangers span 24" and features built-in nailers and T-bar clips. J-box has poke-home connectors and built-in Romex clamps. Socket clips to trim to ensure proper and consistent lamp position. Standard 26TRT, 120V electronic ballast (4-pin lamp) with end of life protection. Class P thermally protected against improper contact with insulation.

Listings

UL Listed to U.S. and Canadian safety standards. Approved for FCC grade B residential use.

Premium open trim, wide flange

601 White

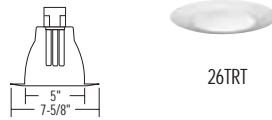

Premium deep baffle, narrow flange

6B2 Black
6B2W White

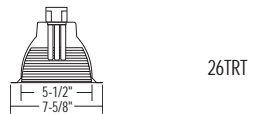

Premium eyelid wallwash w/baffle

6W2 Black
6W2W White

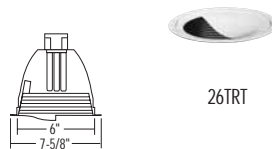

Premium open trim, narrow flange

602 White
602SA Clear diffuse
602A Clear specular
602SG Gold diffuse
602G Gold specular

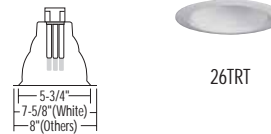

Premium baffle, narrow flange

6B4 Black
6B4W White

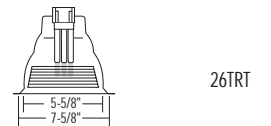

Premium glass lens

6LD3 Drop opal, white splay
6LDB3 Drop opal, black baffle
6LF3 Flush white, white splay
6LFB3 Flush white, black baffle
6L4 Fresnel, white splay
6LB4 Fresnel, black baffle

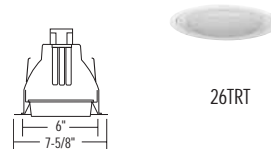

Premium baffle, wide flange

6B1 Black
6B1W White



Premium eyelid wallwash

6W1 White

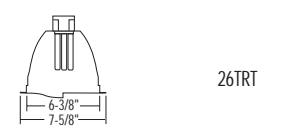

Premium polycarbonate lens

6LD1 Drop opal¹
6LD2 Drop prismatic¹
6LF1 Flush opal¹
6LF2 Flush prismatic¹

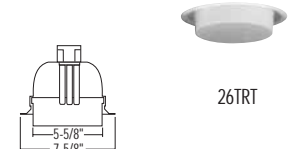

Ordering Information

Example: **CKP62**

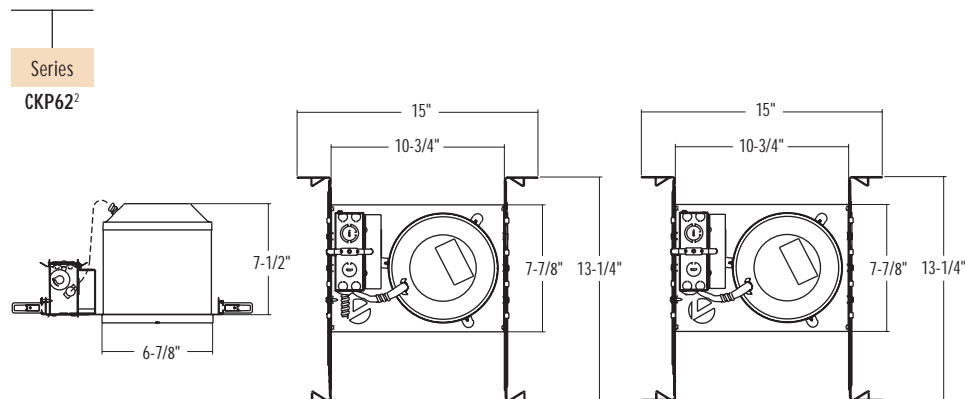

NOTES:

- 1 For plastic flange, add suffix PF to catalog number (Example: 6LD1 PF).
- 2 26TRT, 120V electronic ballast only.

IMPORTANT: For packaging information, see page 322. See specification sheets for complete trim selection.

Drawings are for dimensional detail only and may not represent actual mechanical configuration. Dimensions are shown in inches.

IC/Non-IC Rated – These steplights are damp location listed. Maximum wattage and lamps are listed.

Faceplate	
(blank)	White
BL	Black
Incandescent	
25 A19 (IC)	
40 A19 (Non-IC)	
Fluorescent	
13DTT (IC)	

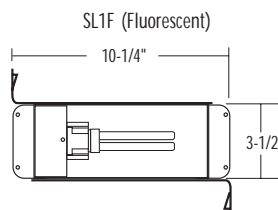
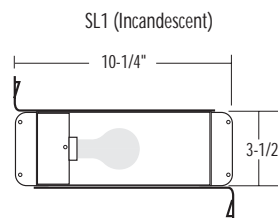
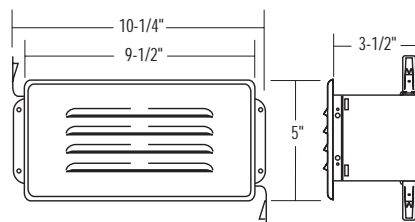
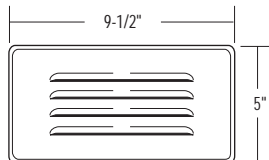
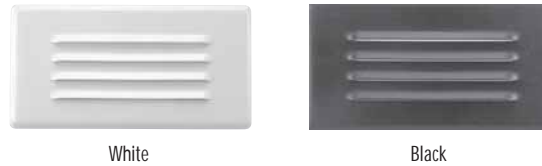

Steplights

Damp Location



Intended Use

Recessed housing rated IC or Non-IC for new construction applications. For indoor use only.

Features

- Approved for through-branch circuit wiring.
- Galvanized steel housing and wiring compartment with a ground wire.
- Bar hangers span 16" with recessed integral nailer tabs.
- Powder-coated steel louver available in white or black finish.
- Butterfly springs hold louver securely in place.
- Die-cut foam gasket seals steel louver against surface, preventing light leaks.
- Encased-and-potted, normal power factor (NPF) electromagnetic ballast standard (Fluorescent only).

Listings

UL Listed to U.S. and Canadian safety standards.

Ordering Information

Example: **SL1F 9DTT BL**

Series	Wattage/Lamps	Faceplate
Incandescent SL1	N/A	(blank) White BL Black
Fluorescent SL1F	9DTT 13DTT	

Drawings are for dimensional detail only and may not represent actual mechanical configuration. Dimensions are shown in inches.

Non-IC Housing

Lensed Squares

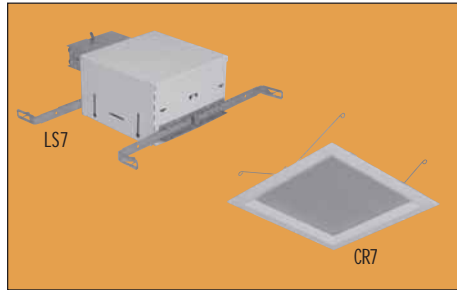

Intended Use

Recessed housing rated Non-IC for new construction applications. Thermally protected against improper contact with insulation and approved for through-branch circuit wiring. Approved for most wiring and ceiling types.

Features

Housing is damp location listed. When trim is installed the complete unit (housing and trim) is wet location listed. Heavy-gauge pre-painted steel housing with galvanized steel J-box. Factory-installed, captive bar hangers span 24" and feature built-in nailers.

J-box has built-in Romex clamps and a ground wire.

Encased-and-potted, normal power factor (NPF) electromagnetic ballast standard (Fluorescent only).

Listings

UL Listed to U.S. and Canadian safety standards.

Non-IC Rated Trims – These trims are for Non-IC applications only. Lamp type and wattage are determined by housing. Lensed trims are wet location listed.

7" lensed squares

FR7 Fresnel

100 A19
2/9TT



FW7 Flat white

100 A19
2/9TT



D07 Drop opal

100 A19
2/9TT



CR7 Corning C73

100 A19
2/9TT



9" lensed squares

FR9 Fresnel

150 A21
3/9TT
1/13TT
2/13TT



FW9 Flat white

150 A21
3/9TT
1/13TT
2/13TT



D09 Drop opal

150 A21
3/9TT
1/13TT
2/13TT



CR9 Corning C73

150 A21
3/9TT
1/13TT
2/13TT

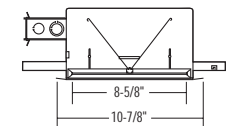
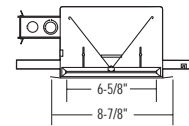

LS7, LSF7

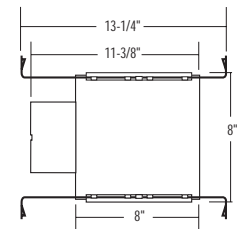
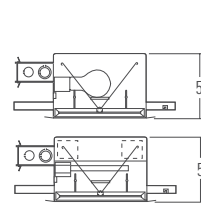

LS9, LSF9

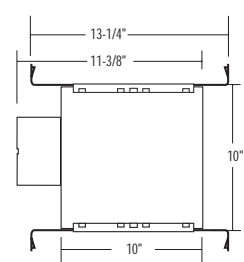
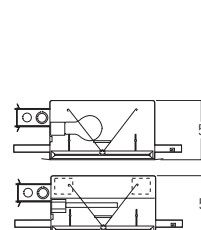

Ordering Information

Example: **LSF9 3/9TT 277**

Series	Wattage/lamps	Voltage	Options
Incandescent	N/A	N/A	N/A
LS7			
LS9			
Fluorescent			HPF High power factor (90% power factor for 120V, 277V and 347V).
LSF7	2/9TT	120	
LSF9	3/9TT	277	
	1/13TT	347	
	2/13TT		

Options & Accessories

Options

These options must be ordered with housing.

Electronic ballast	
GEB10	Generic electronic ballast. <10% THD (total harmonic distortion). Requires four-pin lamp.
MVOLT	Electronic multi-volt ballast capable of operating any line voltage from 120-277V, 50 or 60 Hz. Requires four-pin lamp.

Magnetic ballast	
HPF	High power factor magnetic ballast, 90% power factor.

Miscellaneous	
AT	Sealed airtight housing to minimize air flow through housing. Complies with WSEC and certified per ASTM E283.
PHC	Factory-installed poke-home wire connectors. (12-20 AWG) Meets UL 486 standards for push-in terminals.

Options Compatibility

(These options must be ordered with housing.)

	GEB10	MVOLT	HPF	PHC	AT
LC6				▲	■
L7X				■	▲
L7XR				■	■
LI6				▲	■
LCP				▲	■
L7XP				▲	▲
L7PR				■	■
L5				■	■
L5R				■	■
LI3				■	■
L3				■	■
L3R				■	■
LV3				■	■
LIV3				■	■
LV3R				■	■
L7XF	■	■	■	▲	▲
L7XF RECF				▲	▲
CKP62				▲	▲
LI6F RECF				▲	■
LS					
LSF			■		

■ Option available
 (blank) Option not available
 ▲ Standard

Accessories

Accessories must be ordered separately.

Remodeler clips	
ARC	Used to secure housings in ceiling in remodel applications. Available in master pack of 24 clips.



T-Bar mounting clips	
LSMC	Designed to lock bar hangers to T-bar. Set of 4 clips.

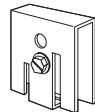

Bar hangers	
LBH	Extended bar hangers used for extreme off-center mounting in a 24" space. Set of two 22" bar hangers.

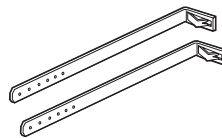

Air-tight (vapor barrier) kit	
ATK	Airtight gasketing seals housing to minimize air flow through housing. Complies with WSEC requirements. Available in master pack of 24 only.

Oversize trim rings	
CTR6	8-3/4" (22.2cm) O.D. 7-1/8" (18.1cm) I.D. (Use with 6, 7, C and F6 Series trims. Compatible with all 7-5/8" flanged trims only. Not compatible with C01 or CB1.



Ceiling thickness extender	
CTE	Use when ceiling thickness is greater than 1-1/2". Maximum thickness 2" (5.1cm). Not compatible with VPE2, VMB4, 6SB1, 6S01, F6 Series or 7-Series trims.

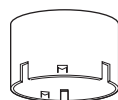

Accessories Compatibility

(These accessories must be ordered separately)

	ARC	LSMC	LBH	ATK3	ATK5	ATK6	ATKR
LC6	■	■	■			■	
L7X	■	■	■				
L7XR							■
LI6		■	■				
LCP	■	■	■			■	
L7XP	■	■	■				
L7PR							■
L5	■	■	■		■		
L5R							■
LI3		■	■	■			
L3	■	■	■	■			
L3R							■
LV3	■	■	■				
LIV3		■	■				
LV3R							
L7XF	■	■	■				
L7XF RECF	■	■	■				
CKP62	■	■	■				
LI6F RECF	■	■					
LS		■	■				
LSF		■	■				

■ Option available
 (blank) Option not available

Packaging

Because Lithonia's downlighting housings and trims are packaged and shipped as separate components (*except steplights, which are shipped as complete fixtures*), they usually are ordered as separate line items. However, housing and trim descriptions may be combined on a single line item.

ORDERED AS SEPARATE LINE ITEMS:			ORDERED AS ONE LINE ITEM:		
Line	Qty.	Catalog No.	Line	Qty.	Catalog No.
1	15	L5	1	15	L5 5B2
2	15	5B2	2	3	LV3 3VB1
3	3	LV3			
4	3	3VB1			

Regardless of ordering method, components will be shipped in optimized packaging:

Master, resale or job pack configurations, if available, with unit packs are used to fill odd lot quantities. To over-ride packaging optimization, items may be ordered specifying the "U" packaging suffix. Specifying unit packaging or ordering quantities that are not even-numbered multiples of available master/job pack configurations may result in higher pricing.

Line	Qty.	Catalog No.*	Description
1	12	L5 M6	2 master cartons containing 6 housings each
2	3	L5 U	3 unit cartons containing 1 housing each
3	12	5B2 M6	2 master cartons containing 6 trims each
4	3	5B2 U	3 unit cartons containing 1 trim each
5	3	LV3	3 unit cartons containing 1 housing
6	3	3VB1	3 unit cartons containing 1 trim each

*Various suffixes are used (after the product description) to indicate packaging configurations.

M followed by a number indicates a master pack of that number of items per shipping carton. Master-packed items are UPC-labeled and packaged appropriately for individual resale, but not for reshipment.

R followed by a number indicates a resale pack of that number of items per shipping carton. Resale-packed items are UPC-labeled and packaged appropriately for individual resale, but not for reshipment.

J followed by a number indicates a job pack of that number of items per shipping carton. Job packed items are not UPC-labeled for individual sale.

Determining the proper placement of recessed fixtures is simple when using the following steps. The guidelines in this section provide general parameters that can be applied in almost any application.

Step 1. Calculate the mounting height.

The mounting height is the distance from the fixture to the work surface. If the work surface is the floor, mounting height equals ceiling height. If the work surface is a countertop, mounting height is ceiling height minus countertop height.

Step 2. Choose the lamp.

Refer to the lamp performance data below to select the lamp that will provide the desired light level at the specified mounting height.

Step 3. Calculate appropriate fixture spacing.

The chart below shows the footcandle (fc) levels and lighted diameter at various mounting heights. The lighted diameter becomes the maximum spacing to achieve uniform light levels and shows the area illuminated for accent lighting.

Mounting Height	5'		8'		10'		12'	
	fc	Dia/ Spacing	fc	Dia/ Spacing	fc	Dia/ Spacing	fc	Dia/ Spacing
R20								
20 watts Flood	22	3.4	9	5.5	6	6.9	4	8.3
20 watts Flood	22	3.4	9	5.5	6	6.9	4	8.3
BR30								
65 watts Flood	19	8.4	7	13.4	5	16.8	3	20.1
65 watts Spot	50	2.3	20	3.7	13	4.6	9	5.5
BR40								
75 watts Flood	18	7.8	7	12.5	5	15.6	3	18.8
100 watts Flood	36	7.8	14	12.5	9	15.6	6	18.8
120 watts Spot	200	1.9	78	3.1	50	3.9	35	4.7
120 watts Flood	52	7.8	20	12.5	13	15.6	9	18.8
120 watts Spot	280	1.9	109	3.1	70	3.9	49	4.7
PAR20 Halogen								
35 watts Narrow flood	36	2.7	14	4.3	9	5.4	6	6.4
35 watts Narrow spot	131	0.8	51	1.3	33	1.6	23	1.9
50 watts Flood	56	2.7	22	4.3	14	5.4	10	6.4
50 watts Spot	128	1.4	50	2.2	32	2.8	22	3.4
50 watts Narrow spot	248	0.8	97	1.3	62	1.6	43	1.9
PAR30 Halogen								
50 watts Wide flood	20	5.5	8	8.9	5	11.1	3	13.3
50 watts Flood	50	3.6	20	5.8	13	7.3	9	8.7
50 watts Narrow flood	76	2.7	30	4.3	19	5.4	13	6.4
50 watts Very narrow flood	108	2.1	42	3.4	27	4.3	19	5.1
50 watts Spot	260	1.1	102	1.7	65	2.1	45	2.5
75 watts Narrow spot	396	0.8	155	1.3	99	1.6	69	1.9
75 watts Flood	88	3.6	34	5.8	22	7.3	15	8.7
75 watts Narrow flood	136	2.7	53	4.3	34	5.4	24	6.4
75 watts Spot	420	1.1	164	1.7	105	2.1	73	2.5
75 watts Narrow spot	620	0.8	242	1.3	155	1.6	108	1.9
PAR38 Halogen								
45 watts Narrow flood	72	2.7	28	4.3	18	5.4	13	6.4
45 watts Spot	180	1.3	70	2.1	45	2.6	31	3.2
60 watts Wide flood	50	5.0	20	8.0	13	10.0	9	12.0
60 watts Narrow flood	146	2.6	57	4.1	37	5.2	25	6.2
60 watts Narrow spot	740	0.9	289	1.4	185	1.7	128	2.1
75 watts Narrow flood	100	2.7	39	4.3	25	5.4	17	6.4
75 watts Spot	480	1.1	188	1.8	120	2.3	83	2.7
75 watts Narrow spot	736	0.7	288	1.1	184	1.4	128	1.7
90 watts Wide flood	60	5.2	23	8.3	15	10.4	10	12.5
90 watts Narrow flood	160	2.7	63	4.3	40	5.4	28	6.4
90 watts Spot	460	1.3	180	2.1	115	2.6	80	3.2
90 watts Narrow spot	900	0.8	352	1.3	225	1.6	156	1.9
100 watts Narrow flood	220	3.2	86	5.0	55	6.3	38	7.6
100 watts Narrow spot	1200	0.9	469	1.4	300	1.7	208	2.1
150 watts Wide flood	100	5.2	39	8.3	25	10.4	17	12.5
150 watts Narrow flood	300	2.7	117	4.3	75	5.4	52	6.4
150 watts Narrow spot	1500	0.8	586	1.3	375	1.6	260	1.9
PAR38 Halogen								
35 watts Flood	64	3.6	25	5.8	16	7.3	11	8.7
35 watts Spot	160	1.6	63	2.5	40	3.2	28	3.8
35 watts Narrow spot	520	0.7	203	1.1	130	1.4	90	1.7
50 watts Wide flood	46	5.2	18	8.3	12	10.4	8	12.5
50 watts Flood	74	3.6	29	5.8	19	7.3	13	8.7
50 watts Narrow flood	98	2.9	38	4.6	25	5.7	17	6.9
50 watts Very narrow flood	136	2.4	53	3.8	34	4.8	24	5.8
50 watts Spot	408	1.2	159	2.0	102	2.5	71	2.9
75 watts Flood	84	3.8	33	6.1	21	7.7	15	9.2
75 watts Very narrow flood	196	2.2	77	3.5	49	4.4	34	5.3
75 watts Spot	512	1.2	200	2.0	128	2.5	89	2.9
PAR38 Halogen								
35 watts Very narrow spot	920	0.4	359	0.7	230	0.9	160	1.0
35 watts Narrow spot	204	0.9	80	1.4	51	1.7	35	2.1
35 watts Narrow flood	47	2.7	18	4.3	12	5.4	8	6.4
50 watts Narrow spot	368	0.9	144	1.4	92	1.7	64	2.1
50 watts Narrow flood	52	2.5x3.2	20	4.0x5.2	13	5.0x6.5	9	6.0x7.8
50 watts Flood	24	3.4	9	5.5	6	6.9	4	8.3

NOTES: The fixture spacing criteria from Step 3 are maximums. Fixture placement should be technically correct and aesthetically pleasing. Work with the spacing criteria and a drawing of the area being illuminated to determine actual fixture placement and number of fixtures needed. Remember, these are only guidelines. Exact fixture location may be impacted by joist spacing, furniture placement and work surface locations.